

PowerContinuity Systems

CRITICAL POWER PROTECTION SPECIALISTS



DESIGN - MANUFACTURE - SUPPLY - INSTALLATION - SERVICE - CARE

- Uninterruptible Power Supplies
- Diesel Generators
- Resilient Power Systems
- LV Switchgear & Panels
- Fuel Systems
- Energy Reduction Systems
- Ultimate Power Protection Solutions
- Carbon Footprint Reduction





Caring for your Power Protection Our Commitment to care

Our Clients

Our Prestigious Clients include:

- Boeing
- Britannia Building Society
- Bupa
- Burberry Plc
- Croda
- Fire and Police Service
- First Data Corporation
- Imperial Hotel Group
- Jaguar Land Rover
- Marstons
- Mothercare
- NHS Direct
- SPAR
- TEVA



CRODA

Burberry



NHS
Direct



TEVA

MoneySupermarket.com

Power Continuity Systems
Head Office:
Spinney Hill
Derby DE73 8LX
0845 055 8455
sales@powercontinuity.co.uk

Our Commitment to yourPower Continuity

At PCS our engineers have over 25 years of experience designing and installing continuous power protection systems for leading critical sites in the UK.

Banks, Hospitals and mission critical locations which necessitate power continuity 24-7 chose PowerContinuity Systems when failure is not an option.

Our qualified engineers precisely evaluate your system requirements to provide the correct power solutions ensuring seamless power every day of the year, regardless of outside forces.

Site surveys will ensure all aspects of the our quotation are accurate and will allow for future growth as your operations expand in the coming years.



Our Commitment to yourPower Protection

- **Improving** your power supply
- **Assessment** of existing power distribution systems
- **Analysis** of input power supply and present efficiency
- **Site specific surveys** to ensure the client's needs are covered including multiple power options with drawings provided from our own CAD facilities
- **Power Protection Solutions**



Our Commitment to your .. Uninterruptible Power Supplies UPS

Uninterruptible Power is crucial for any Comms Room Environment. Seamless Clean Power Systems ensure the elimination of disruptive brown outs and power surges allowing flawless connectivity throughout your universe.

Power Continuity requires careful, detailed forward planning encompassing future growth with scope for non disruptive upgrades. Anticipated network expansion at the design stage, will produce cost saving installations reaping the rewards well into the next decade.

Modular, Expandable, 'GREEN UPS' systems for continuous power requirements are the trade mark of Power Continuity Installations. Power Protection with environmental responsibility.

Let us provide your IT environment with upgradable UPS installations that grow with you.

Imagination - Implementation - Installation - Expansion without Disruption - Power Continuity.

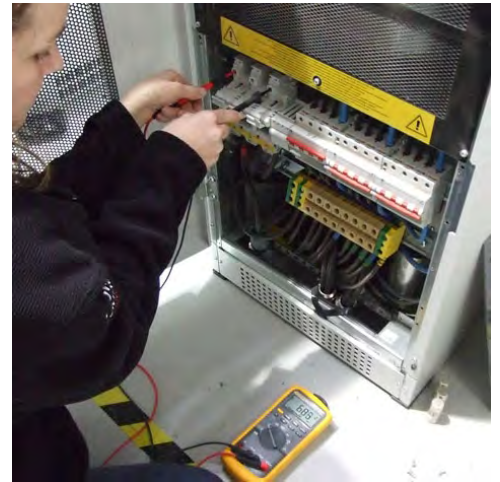

- Design
- Consultation
- Schematics
- Choice of UPS Systems
- N+N, N+1, N+2 Resilience
- Installation
- BMS and SNMP Systems
- Power Factoring
- Voltage Optimization Systems Technologies.

**Control your own destiny.
Control your own uninterruptible power supplies.
Control your own power expansion with Power Continuity Systems.**



Our Commitment to your .. Uninterruptible Power Supplies UPS



PowerContinuity designs, manufactures and installs Uninterruptible Power Supplies (UPS). From single phase to three phase supplies, UPS Power Systems from 1kVA to 6MVA either stand alone or parallel systems - N+N, N+1 and N+2 resilience.

Our experienced teams, with over 20 years experience, will guide you from the initial site survey and consultation through to UPS installation, commission and our after sales service maintenance plans.

PowerContinuity Systems are totally independent and can therefore recommend the best solution for your organisation with complete impartiality. PCS work with all leading UPS manufacturers.



PowerContinuity Systems deal with all the leading brands of UPS and are 100% independent so you can always be assured that the system recommended is the most suitable for your requirements.

Our team is fully trained and experienced to advise you as to the best UPS option.

We pride ourselves on the industry leading reputation we have with power protection guaranteeing exceptional customer service. PCS already protect over 6 million UK end users every day and growing.

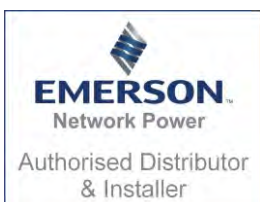

Our Commitment to yourEmergency Backup Power Generator systems

Continuous Power is crucial for every Comms Room Environment, not merely short time power. UPS provide seamless Clean Power Systems for the elimination of disruptive brown outs bridging short power outages without disruption, but for how long? 30 minutes? 60 minutes? Thereafter you require automatic backup generator power protection.

Power Continuity provides the automated long term power protection systems for key sites across the UK. Dependable power 24-7. Power you control without the National Grid Generator systems for continuous power requirements lasting from 12 hours to 12 days.

- Power Outages Happen
- PCS experience offers you the peace of mind
- When failure is not an option
- Power without limits - Connectivity without Disruption.
- Conception
- Design
- Consultation
- Schematics
- Choice of Generator Systems from 100kVA to 10 mW
- N+N, N+1, N+2 Resilience
- Installation
- Inside Buildings- External Systems - Any location
- BMS and SNMP Systems
- Fuel Systems

Control your own destiny
Control your own unbreakable power system.

Power Continuity Systems is your business continuity partner for total site power protection.



**PowerContinuity
is Business Continuity**



SCANIA



IVECO



Our Commitment to yourEmergency Backup Power Generator systems

Power Continuity Systems design, manufacture and install bespoke diesel generators.

From open set to acoustic canopies, standby or prime, 30kVA to 3MVA, PowerContinuity will provide you with a bespoke power protection solution in virtually any location.

Our experienced generator engineering teams, will guide you from the initial site survey and consultation through to installation, commissioning with second-to-none after sales servicing and maintenance plans.

Again, we are totally independent in our recommendations to you offering engines from the worlds leading generator manufacturers giving us complete impartiality in supply and working with all leading generator brands.

Not every generator location is easily accessible - PowerContinuity has successfully carried out generator installations in some very demanding locations efficiently and safely.



- City centre roofs
- Secure facilities
- Remote locations
- Off shore
- Secure sites
- Financial institutions



Our Commitment to yourRotary UPS systems

Rotary UPS systems offer specific advantages to traditional UPS systems. Traditional static UPS are great for clean loads like data centres, servers and computers but do not like disturbing loads such as motors and heating. With a rotary UPS, using flywheel technology, there is no sensitivity to disruptive loads and you can back up your entire operations.

This is particularly well suited to production facilities where even a short power blip can cause millions of pounds in lost production.

PowerContinuity Systems have supplied and installed rotary UPS systems up to 4MW in size. By offering both static and rotary UPS' we can provide you with the best power protection system personalised to your needs and requirements.

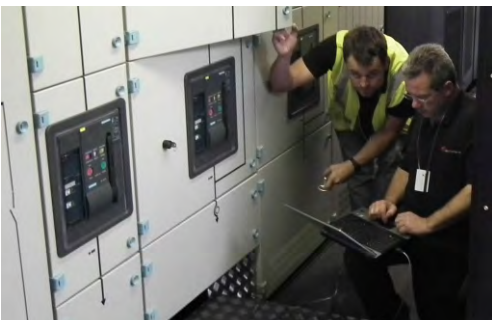

Our Commitment to yourLV Switchgear & Panels

Power Continuity Systems design, manufacture and install bespoke LV switchgear and mains distribution boards up to 7000A.

Each panel is designed for your specific requirements including your choice of breakers, metering equipment and location of incoming and outgoing compartments.

We can also provide automatic changeover sections for your generators and uninterruptible power supplies.

Our experienced installation teams can install the main distribution panels to suit your site requirements. This can include night and weekend working to minimise any disruption to your critical operations.

In addition to LV works, we can also supply and install HV transformers, HV ring mains and HV transmission infrastructure.



Our Commitment to your Comms Room

Uninterruptible Power combined with Emergency Standby power is crucial for any Comms Room Environment. PCS not only provides Power Protection. We can provide the complete Comms Room Environment.

Comms Room Power Continuity also requires A/C cooling, Environmental controls, Cabinets, Data Cabling, Fire Suppression, Security etc. PCS provide upgradable Comms Room installations that grow with you, from conception to site population.

- Implementation - Installation - Expansion without Disruption.
- Design
- Consultation
- Schematics
- Choice of UPS Systems/Manufacturers
- N+N, N+1, N+2 Resilience
- Installation
- BMS and SNMP Systems
- Air Conditioning



Complete Data Installation Power Continuity Systems for your Comms Room Environment



Complete Data Installation Power Continuity Systems for your Comms Room Environment

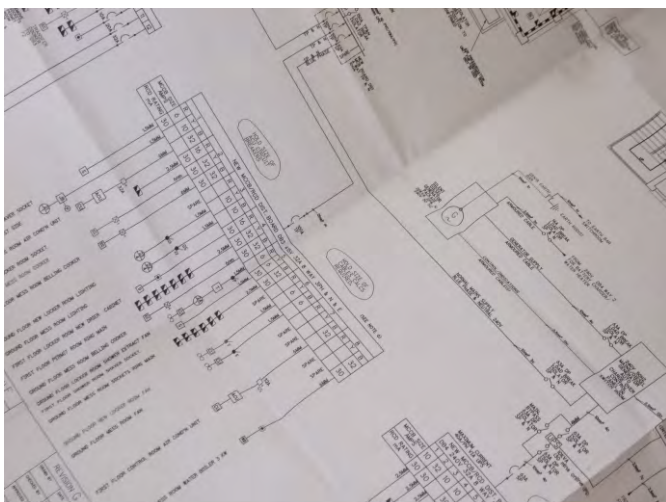

Our Commitment to your Data Centre

Power Continuity design, manufacture and install mobile data centres. If you are fast outgrowing your traditional bricks and mortar data centre and require a quick expansion to your data capabilities or want the flexibility of being able to take your data centre with you when you move, a containerised mobile data centre is just what you need.

Our mobile data centres are purpose built to your particular requirements allowing you to choose from comfort cooling, Environmental controls, UPS and generator backup, Fire Suppression systems, Security etc.

- Choice of ISO container for ease of transport or nonISO for flexibility of racks
- 90 minute fire resistance
- In row cooling
- Remote monitoring system
- Fire and smoke safe cable entry
- Hot and cold aisle containment
- Early fire detection system and fire suppression system

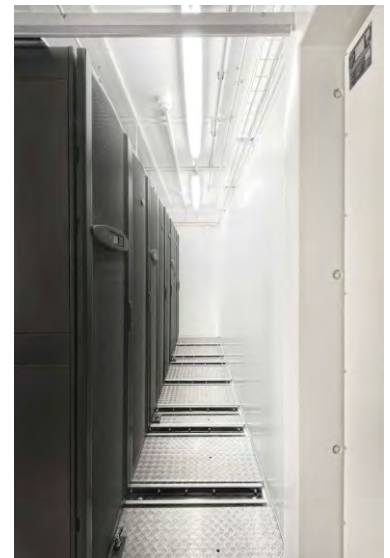

Bespoke Mobile Data Centres Purpose Built for your Exacting Requirements



Our Commitment to yourDesign Brief

From Conception to Commissioning - every Power Protection Project begins with a site meeting where one of our project engineers discusses every aspect of the intended design , preparing the way for a seamless installation project from imagination to implementation.

Each Design is prepared to your requirements with site specific CAD drawings , showing power loadings.

Engineers are all qualified in the field, ready to assist from the smallest to the most complex PCS uninterruptible power supplies installation comprising UPS power systems and backup emergency power generator solutions.

Fully automatic Power Protection installation systems 24/7 - 365.

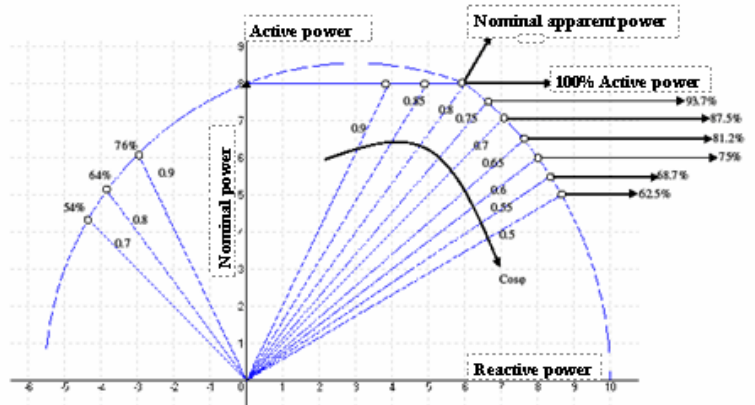
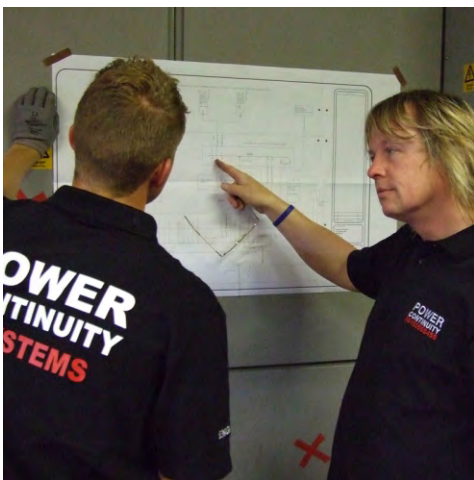

Our Commitment to yourResilience

Power Protection provides confidence in a world that lacks confident power security.

PowerContinuity Systems design, build, supply and install the most resilient power protection systems available. UPS power systems with N+N, N+1 and N+2 for 'robust' resilience together with backup emergency power generator solutions of N+N, N+1 and N+2 with unlimited running time.

When failure is not an option

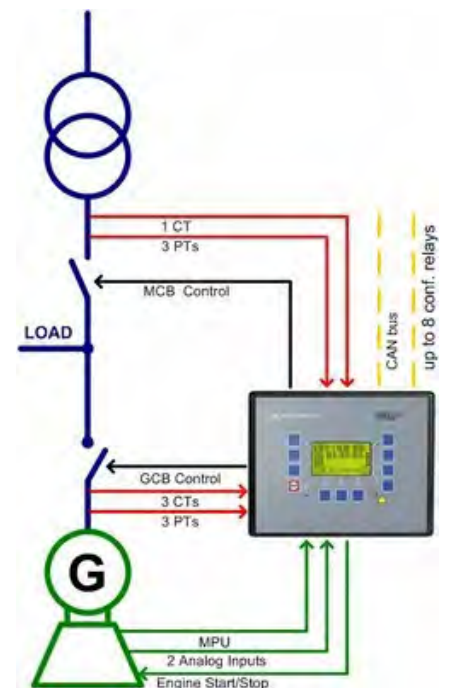
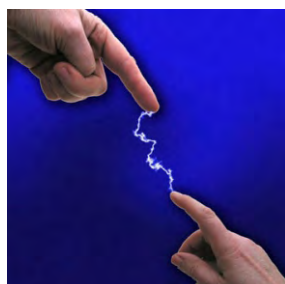

Our Commitment to yourService

You are unique. Your business is unique. Our service for your company is unique.

Project Specific attention to detail with a dedicated project engineer leading from design to implementation keeps your project individuality.

Quality at every stage of the way - PowerContinuity Systems are accredited ISO 9001, ISO 14001, ISO 18001, ISO 27001, ISO 25995.

Track record of success ensuring seamless power protection covering over 16% of UK individuals in their day to day activities and growing.

Our prestigious clients expect the best, and receive the best.



Our Commitment to yourMission Statement

Power Continuity Systems is committed to your company mission statement.

Power Protection with Energy Saving has been our focus for decades and we can share our power saving skills for your companies vision.

Together let's provide a safe power environment for your business continuity.



Our Commitment to yourService and Maintenance



PowerContinuity Systems specialist engineers can also repair and maintain most makes of engines, even the unusual.

Generator maintenance will protect your power investments. Our maintenance and generator service visits will keep your generator in peak performance. Prevention is better than cure, a regular maintenance regime makes economic sense.



Eliminate downtime - specialist servicing helps prevent equipment failure and power failure. To keep your generator in it's peak PowerContinuity Systems provides 2 generator service and maintenance visits per year with optional load bank testing if required.

Generator Maintenance:

- Preventative checks
- Service
- Monitoring
- Load Banks
- Commissioning
- Certification
- Emergency Call Outs
- HV Maintenance
- LV Maintenance



Our Commitment to yourService and Maintenance

Regular Maintenance and Service are crucial in order to maintain all Power Protection Systems at peak performance, when you need them most.

PCS ensure the correct service regime for all your UPS and Generator Systems.

Power Continuity Systems engineers are factory trained on each of the systems that we recommend and install. Skill where it counts the most, on the front line.

Confidence knowing PCS operate 24-7-365 across the UK with a 4-6 hour response to site.

Power Continuity Installations are cared for by our dedicated skilled team of engineers.

Let us provide additional on site training for your personnel to ensure weekly protocols are followed to provide peace of mind in an uncertain world.

Round the clock service and maintenance - All calls answered 24-7

Mainland UK Response

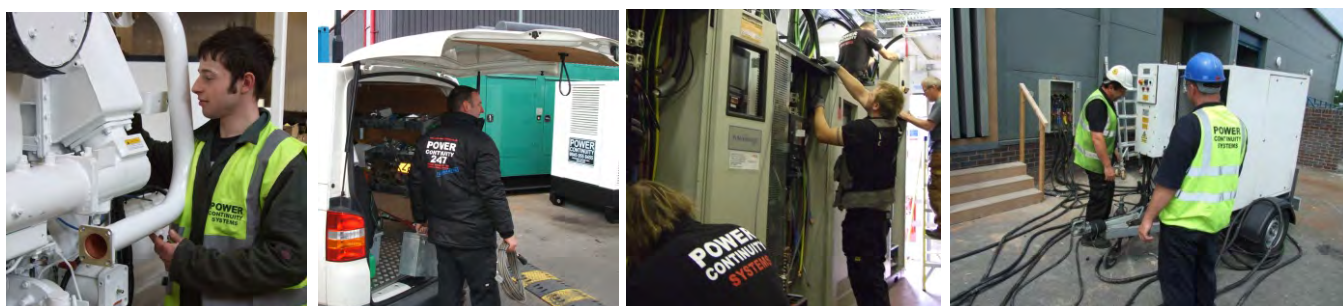

UPS servicing and maintenance is absolutely necessary in order to keep your UPS systems in optimal performance. All servicing and maintenance is carried out in accordance with the UPS manufacturer's specifications and requirements by fully trained and qualified engineers.

PowerContinuity System's network of specialist UPS Systems Engineers can repair all UPS makes including the lesser known brands. Security of power requires a regular UPS servicing regime.

All types of UPS maintenance including:

- UPS Servicing
- Battery testing
- UPS Testing
- UPS component replacement
- Battery replacements



Our Commitment to your Uninterruptible Power Hire

Uninterruptible Power Hire can be short time or long term.

Generator Power can be for immediate or predictable power outages

Power Continuity provides a complete range of UPS and Generator Systems for temporary installations. Modular, Containerised or in-house short-term installations.

Locations is no issue for Power Continuity Installations.

Let Power Continuity Systems provide your temporary Power Protection requirements.

Temporary Power Continuity in the UK

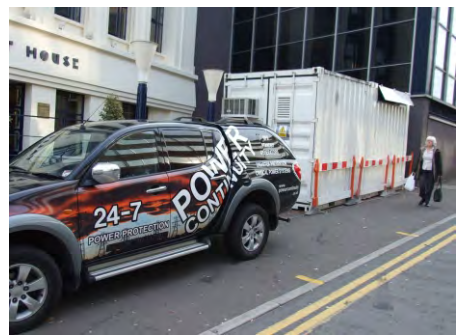

Our Commitment to yourGreen UPS systems and Energy Cost Reduction

Carbon Footprint Reduction needs to be real and sustainable. PCS can reduce both your existing energy costs as well as reduce the future energy consumption . Our Comms Room Power Systems will reduce both your CO2 footprint and achieve huge tangible financial savings.

- GREEN UPS Power Systems
- UPS from 10 kVA to 10 mW
- Expandable GREEN UPS Systems
- ECA approved
- Power Continuity Track Record
- Resilience with Compliance
- Provable Energy Reduction
- Lighting Systems reduced power
- Power Factoring
- Voltage Optimization Systems Technologies.



PCS Site survey to help your power project comply with the latest carbon footprint regulations and reduce your ongoing costs.

Our Commitment toSafe Disposal

Power Continuity Systems is a registered waste remover and carrier with the Environment Agency. Any waste removed from your site will be environmentally disposed of in conjunction the latest Environment Agency directives. Your World is our World.

Redundant Equipment and Batteries are no issue. Whatever the size or location, PCS has the knowledge and equipment to remove any redundant system and its batteries before they become a health hazard.

Redundant UPS Systems and Generators removed and disposed of environmentally.



Our Commitment to yourEnvironment

Your Environment is our Environment

Our UPS installations comply with ECA certification for CO2 reduction.

In fact we are able to offer total efficiency of virtually 100% even with low loads of 25% as well and your company can access financial incentives from the Carbon Trust.



CO2 reduction is crucial to protect our environment.

Our UPS installation projections show huge CO2 reduction over a 10 year period in comparison to non GREEN technology.

Our UPS Power Systems are as GREEN as they come, with the very latest GREEN technology.

Ask for a demonstration to prove the GREEN credentials, we are pleased to offer tangible proof to our environment commitment.

Our Commitment to yourEnergy Cost Reduction

- **Running Costs** are spiralling and yet PCS can reduce both your existing energy costs as well as reduce the future energy consumption . Our Comms Room Power Systems will reduce both your CO2 Tonnes as well tangible financial savings.
- UPS Power Systems
- Generators Standby and Prime Power
- Lighting Systems
- Power Factoring
- Voltage Optimization Systems Technologies
- All our engineers can assist your company with a site survey to help your power project comply with the latest regulations as well as help to reduce your costs and carbon footprint.

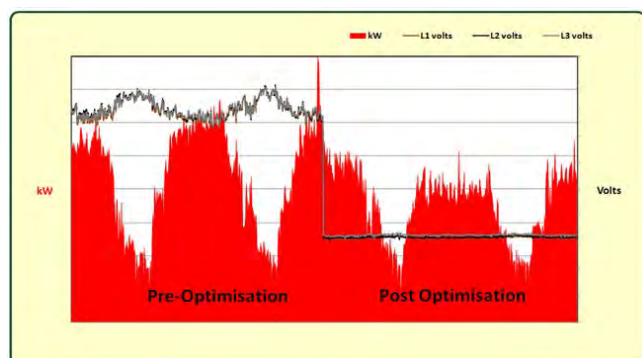



Power with Responsibility When failure is not an option TM

